

USER MANUAL Fixturlaser EVO



CONTENT

Welcome to our world	1.1
Declaration of Conformity	2.1
Safety	3.1
Care	4.1
Main Menu	5.1
Shaft Alignment	6.1
Horizontal Machines	
Shaft Alignment	7.1
Vertical Machines	
Machine Defined Data	8.1
Softcheck	9.1
Target Values	10.1
Tolerance Table	11.1
Memory Manager	12.1
Global Settings	13.1
Display Unit EVO D	14.1
Sensors M3 and S3	15.1
Technical Specification EVO D	16.1
Technical Specification M3 and S3	17.1

WELCOME TO OUR WORLD

Since the very beginning in 1984, ELOS Fixturlaser has helped industries throughout the world to achieve more profitable and sustainable production. We have reached where we are today by having the courage to think beyond the norm and follow slightly unconventional paths. We have had the courage to make mistakes and find new directions. Through our resolve, ambition and knowledge we have become a global player and a leader in innovative, user-friendly shaft alignment.

SUSTAINABLE INNOVATIONS

During our almost 30 years in this industry, we have explored, tweaked and tested more than anyone. Some might say we are incurable innovators whereas others might say that we are highly focused. They both

probably have a point. If we had not been devoted and ambitious, we would not have been the first in the industry to have a touch screen. Nor would we have been pioneers in the use of visible lasers and dual measurement heads.

Over the years, we have learnt to never compromise on quality and we are constantly in search of new, unexplored opportunities by combining advanced technology with design and function. By doing so, we have become the leading innovator in our industry. Not only do we minimize wear, production stoppages and costs, we also help save the environment. Natural resources are in short supply and if we can contribute to a more sustainable world by making it a little bit straighter, we couldn't be happier.

TRUE COMMITMENT

One reason for our success is our solid commitment. We have ensured that we remain attentive to constantly pick up on the needs of the market. Our expert employees and dedicated dealers in over 70 countries are undoubtedly our most important asset. Satisfaction and team spirit are of particular importance to us and are consistently at the top of our priority list. With experience from a wide range of industries and manufacturing processes, we are fully aware of the problems and needs of our end-customers. We are passionate about what we do and we are driven by the desire to eliminate anything in the industry worldwide that may be even slightly out of line.

PURE USABILITY

Our design and user-friendliness are carefully interwoven. As we develop new products, they also become cleaner, smarter, more functional and more robust. An industrial environment is demanding, infinitely more difficult to work in and inevitably subject to time pressure. There is no place for equipment with unnecessary functions, complicated interfaces and that is difficult to assemble.

Usability and user friendliness mean everything, not only to us but also to our customers. We have designed products that are easy to learn and can be incorporated quickly. By removing non-essential functions, we make life less difficult for our users – and probably a little more difficult for our competitors.

END USER LICENSE AGREEMENT

The rights to use the software in this product are offered only on the conditions that you agree to all the terms stated below, i.e. the end user agreement. By using this product you agree to be bound by this agreement. If you do not accept this agreement your sole remedy is to return the entire unused product, hardware and software, promptly to your place of purchase for a refund.

The user is granted a single license to use the software contained in this product. Use is only permitted on the hardware it has been installed on at the time of purchase. The software may not be removed from the hardware.

The software contained in the system is the property of Elos Fixturlaser AB, any copying or redistribution is strictly prohibited.

Modifying, disassembling, reverse engineering or decompiling the system or any part thereof is strictly prohibited.

Disclaimer of warranties: To the maximum extent permitted by applicable law, Elos Fixturlaser AB and its suppliers provide the software contained in this product 'as is' and with all faults, and hereby disclaim all other warranties either expressed, implied or statutory.

Limited liability: No liability shall exceed the price of the product, and the sole remedy, if any, to any claim shall be a right of return and refund.

Elos Fixturlaser AB or its suppliers shall, to the maximum extent permitted by applicable law, not be liable to any indirect, special, incidental, punitive, and consequential damages arising from the use of the system or any part thereof, authorized or unauthorized.

DECLARATION OF CONFORMITY

In accordance with the EMC Directive 2004/108/EC, the Low Voltage Directive 73/23/EEC, including amendments by the CE-marking Directive 93/68/EEC & EC directives RoHS 2011/65/EU.

Type of equipment

Alignment System

Brand name or trade mark

Fixturlaser EVO

Type designation(s)/Model no(s)

I-0935 Fixturlaser EVO D

I-0913 Fixturlaser M3

I-0914 Fixturlaser S3

Manufacturer's name, address, telephone & fax no

Elos Fixturlaser AB
Box 7
SE-431 21 Mölndal
Sweden

Tel: +46 31 7062800

Fax: +46 31 7062850

The following standards and/or technical specifications, which comply with good engineering practice in safety matters in force within the EEA, have been applied:

Standard/Test report/Technical construction file/Normative document

Emission: EN 61000-6-3:2007.

Immunity: EN 61000-6-2:2005, EN 61000-4-2, -3, -4, -5, -6, -11.

ISO9001:2008 Ref. No/ Issued by: DNV
Certification AB Certification No. 2009-
SKM-AQ-2704/2009-SKM-AE-1419.

The laser is classified in accordance with the
International Standard IEC-60825-1:2007,
USA FDA Standard 21 CFR, Ch I, Part
1040.10 and 1040.11 except for deviations
pursuant to laser notice No. 50, dated June
24, 2007.

The wireless device complies with Part 15 of
the FCC Rules. Operation is subject to the
following two conditions;

- (1) this device may not cause harmful
interference, and
- (2) this device must accept any interference
received, including interference that may
cause undesired operation.

Additional information

The product was CE-marked in 2014.

As manufacturer, we declare under our sole
responsibility that the equipment follows the
provisions of the Directives stated above.

Date and place of issue

Möln dal 2014-03-11

Signature of authorized person

A handwritten signature in black ink, appearing to read 'Hans Svensson', written in a cursive style.

Hans Svensson, Managing Director

SAFETY

Retain and follow all product safety and operating instructions. Observe all warnings on the product and in the operating instructions.

Failure to observe the safety pre-cautions and operating instructions can cause bodily injury, fire, and damage to the equipment.

Do not disassemble, modify or use the equipment in other ways than explained in the operating instructions. Fixturlaser will not accept any liability for such use.



WARNING!

Do not mount equipment on running machines and take all appropriate measures to prevent unintentional start-up of machines. Make sure to fully comply with all appropriate shut down procedures, safety measures and regulations at worksite and local regulations regarding safety in a machine environment.

LASER PRECAUTIONS

Fixturlaser EVO uses laser diodes with a power output of < 1.0 mW. The laser classification is Class 2.

Class 2 is considered safe for its intended use with only minor precautions required. These are:

- Never stare directly into the laser transmitter.
- Never shine the laser directly into anyone else's eyes.

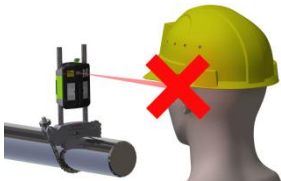

COMPLIES WITH 21 CFR 1040.10 AND 1040.11
EXCEPT FOR DEVIATIONS PURSUANT TO
LASER NOTICE No. 50, DATED JUNE 24, 2007



CAUTION!

USE OF CONTROLS OR
ADJUSTMENTS OR
PERFORMANCE OF
PROCEDURES OTHER THAN
THOSE SPECIFIED HEREIN
MAY RESULT IN
HAZARDOUS RADIATION
EXPOSURE.

Your system complies with the requirements in:

- IEC-60825-1:2007
- British Standard BS EN 60825-1
- DIN EN 60825-1

USA FDA Standard 21 CFR, Ch I, Part 1040.10 and 1040.11

POWER SUPPLY

Fixturlaser EVO is powered by a high-capacity rechargeable Li-Ion battery mounted in the display unit or by the external power unit.



Both the display unit and the measurement units (M3 and S3) can be connected to the charger and charged while lying in the case. It is important that the lid of the case is open during the charging or else the system will not be charged properly and might be damaged.

When used in typical conditions the battery will sustain good capacity for approximately 2-3 years before needing replacement. Contact your sales representative for battery replacement.

The batteries contain safety circuitry to operate safely with the display unit. The unit can therefore only be used with the Li-Ion batteries supplied by Fixturlaser.

Improper replacement of batteries can cause damage and risk for personal injury.



WARNING!

BATTERY REPLACEMENT SHALL ONLY BE PERFORMED BY AUTHORIZED FIXTURLASER REPRESENTATIVES.

USE OF ANY OTHER BATTERIES THAN THOSE SUPPLIED BY FIXTURLASER WILL CAUSE SEVERE DAMAGE TO THE DISPLAY UNIT AND CAN CAUSE RISK FOR PERSONAL INJURY!

Handle any batteries with care. Batteries pose a burn hazard if handled improperly. Do not disassemble and keep away from heat sources. Handle damaged or leaking

batteries with extreme care. Please keep in mind that batteries can harm the environment. Dispose of batteries in accordance with local regulatory guidelines, if in doubt contact your local sales representative.

Only use the external power adapter supplied by Fixturlaser for use with the Display Unit. Using other power adapters can cause damage to the unit and personal injury.

WIRELESS TRANSCEIVER

The Fixturlaser EVO system is fitted with a Bluetooth wireless transceiver.

Make sure that there are no restrictions on the use of radio transceivers at the site of operation before using the wireless transceivers.

Please refer to the chapter “Global settings” on how to turn off the Bluetooth transmitters for use in restricted environments.



WARNING!

Before using the wireless transceivers make sure that there are no restrictions on the use of radio transceivers at the site. Do not use on aircraft.

CARE

The system should be cleaned with a cotton cloth or a cotton bud moistened with a mild soap solution, with the exception of the detector and laser window surfaces, which should be cleaned with alcohol.



For the best possible function, the laser diode apertures, detector surfaces and connector terminals should be kept free from grease or dirt. The display unit should be kept clean and the screen surface protected from scratches.



Do not use paper tissue, which can scratch the detector surface.



Do not use acetone.

The chains on the V-block fixtures are delivered dry. If the system is used in highly corrosive environments, the chains should be oiled.

DATE OF CALIBRATION DISCREPANCY

Our instruments store the electronic date of the latest calibration of the instrument. Due to production processes and storage time, this date will differ from the date of the calibration certificate. Hence, it is the date of the calibration certificate which is important and that indicates when the next calibration is due.

MAIN MENU

The Fixturlaser EVO is provided with different programs for specific purposes.



Press the ON button to start the system and the Main Menu appears.



In the Main Menu you can select the program that you want to use.

In the Main Menu you will also find the Memory Manager and Global Settings.

APPLICATION PROGRAMS



Shaft Alignment Horizontal
Machines



Shaft Alignment Vertical Machines



Machine Defined Data

MEMORY MANAGER



Memory Manager

SYSTEM FUNCTIONS



Global Settings



Off



Wireless indicator



Battery indicator

SHAFT ALIGNMENT HORIZONTAL MACHINES

INTRODUCTION

Shaft alignment: Determine and adjust the relative position of two machines that are connected, such as a motor and a pump, so that the rotational centers of the shafts are collinear, when the machines are working in a normal operating condition. Correction of horizontal shaft alignment is done by moving the front and the rear pair of one machine's feet, vertically and horizontally, until the shafts are aligned within the given tolerances. A tolerance table is available in the system.

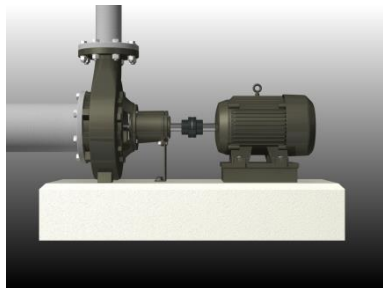

The Fixturlaser EVO system has two measuring units that are placed on each shaft by using the fixtures supplied with the system.

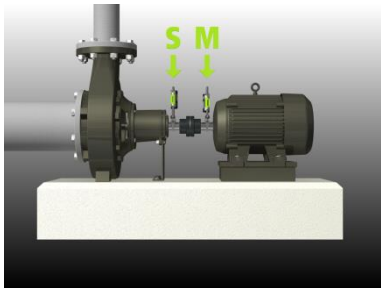

After rotating the shafts into different measuring positions the system calculates the relative distance between the two shafts in two planes. The distances between the two measuring planes, distance to the coupling and distances to the machine feet are entered into the system. The display box then shows the actual alignment condition together with the position of the feet.

Adjustment of the machine can be made directly, according to the displayed values.

The alignment results can be saved in the memory manager. The measurements in the memory manager can easily be transferred to a PC for further documentation purposes.

PRE-ALIGNMENT FUNCTIONS

In an effort to obtain the best possible conditions for shaft alignment, it is necessary to perform some pre-alignment checks. In many cases it is necessary to make these checks in order to obtain precise alignment. It is often impossible to reach the desired alignment results if you do not make any pre-alignment checks.

Before going on site, check the following:

- What are the required tolerances?
- Any offsets for dynamic movements?
- Are there any restrictions for mounting the measuring system?
- Is it possible to rotate the shafts?
- What shim size is needed?

Before setting up the alignment system on the machine, check the machine foundation, bolt and shim condition. Also check if there are any restrictions in adjusting the machine (if e.g. there is enough space to move the machine).

After the visual checks have been performed, there are some conditions that have to be considered:

- Check that the machine has the right temperature for alignment.
- Take away old rusty shims (check that you can remove shims).
- Check coupling assembly and loosen the coupling bolts.
- Check soft foot conditions.

- Mechanical looseness.
- Check coupling and shaft run-out.
- Pipe work strain.
- Coarse alignment.
- Check coupling gap (axial alignment).

MOUNTING

The sensor marked “M” should be mounted on the movable machine and the sensor marked “S” on the stationary machine. The sensors shall be assembled on their V-block fixture, and placed on each side of the coupling.

Hold the V-block fixture upright and mount it on the shafts of the measurement object.



Lift the open end of the chain, tension it so that the slack is removed and attach it to the hook.



Firmly tighten the chain with the tensioning screw. If necessary, use the supplied tensioning tool. Do not over-tighten. If the shaft diameter is too large the chains can be extended with extension chains.



Adjust the height of the sensor by sliding it on the posts until a line of sight is obtained for both lasers. Secure its position by locking both clamping devices on the back of both units



The laser of the M-sensor can be adjusted with the adjustment screw on the top of the unit. There is normally no need to adjust the laser, but this might be necessary when measuring at long distances.

NOTE: Make sure that the adjustment screw is secured with the locking nut after adjustment.

STARTING THE PROGRAM



Start the program by touching the Horizontal Shaft Alignment icon in the Main Menu.



Go to Settings for selecting measurement method and other settings.

SETTINGS

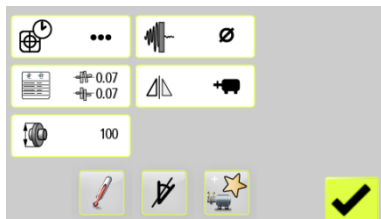

These settings are unique for this application.

For most of the settings, the current selection is shown in the icon.

Sampling time

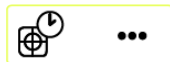

Opens window for selection of sampling time. Select normal or long sampling time.

Long sampling time is suitable for high vibration environments.

Tolerance table

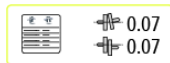

Opens the tolerance table. See chapter “Tolerance table”.

Coupling gap

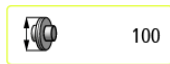

Opens window for entering of coupling diameter.

Adjustable screen filter

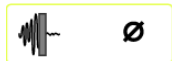

Opens window for activating or deactivating the adjustable screen filter.

Note: The adjustable screen filter should be deactivated for normal operation, and only activated in environments with severe vibrations.

Screen flip

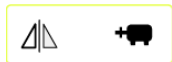

Opens window for selection of selection of screen flip. Select normal screen or screen flip.

Target values



Opens Target values. See chapter “Target values”.

Turn off inclinometers

If the inclinometers are not functioning properly, e.g. in high vibrations, they can be disabled.



Turns off the inclinometers.

Measurement with disabled inclinometers is described in the end of this chapter.

Add new machine with defined data



Opens window for adding a new machine with defined data to Machine Defined Data.

Entered data such as distances, Target values and tolerances, will be saved.

Confirm



Exits the Settings and returns to the application.

ENTER DIMENSIONS

The screen displays the movable machine.

The traffic lights show green when the laser hits the detector.

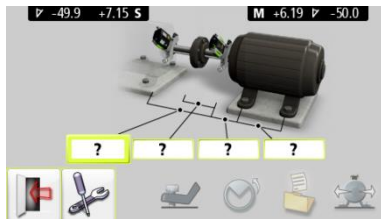

Select the dimension boxes to enter dimensions.

Measure and enter dimensions and tolerance.

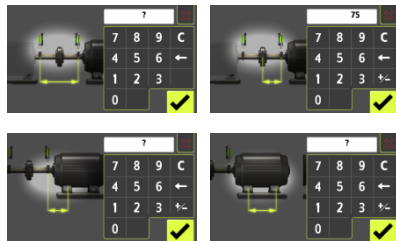

You must enter all the distances. The distance between the sensors, the distance between the centre of the coupling and the M-sensor, the distance between the M-sensor and the first pair of feet and the distance between the first and the second pairs of feet.

SOFTCHECK



Go to Softcheck for checking soft foot conditions.

See chapter “Softcheck”.

TARGET VALUES



Go to Target Values for entering target values.

See chapter “Target Values”.

MEASUREMENT METHOD



Tripoint™ method

In the Tripoint method, the alignment condition can be calculated by taking three points while rotating the shaft at least 90° .

NOTE: The shafts should be coupled during measurement in order to achieve as reliable and accurate results as possible, when using the Tripoint method.

TIP: The larger the angle over which the three points are measured, the fewer moves and repeat measurements will have to be made. Minimum angle between readings is 45° .



A green flashing arrow suggests suitable measurement positions.

MEASUREMENT POINT REGISTRATION

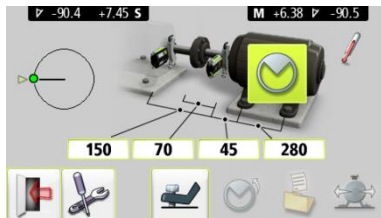

Set the sensors at approximately the same rotational angle at the first measurement position.



Touch the register icon.

This registers the first reading.

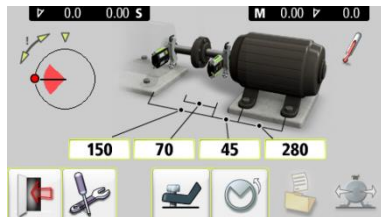

Rotate the shafts to the next position. The shafts must be rotated over a minimum of 45° .

Green sector show permitted positions. Red sector show forbidden positions. The Register icon is not shown if the rotation is less than 45° .

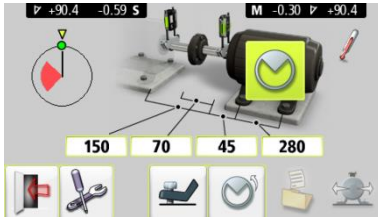

Touch the register icon.

This registers the second reading.

Rotate the shafts to the third position.

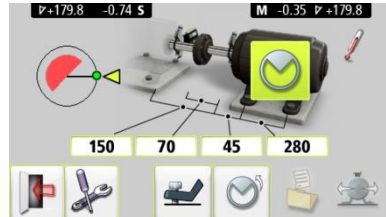

Touch the register icon.

This registers the third reading.

TIP: When registering the third reading at the 3 o'clock position, the sensors will already be in the right position for horizontal alignment.

MEASUREMENT RESULTS



The Measurement Result screen shows coupling values and foot values in both the vertical and horizontal direction.

The symbol to the left of the coupling values indicates the angular direction and offset, and also if the values are within tolerance.



Within tolerance (green).



Within double tolerance (yellow and inverted).



Out of double tolerance (red and inverted).



When a coupling is in tolerance in one direction, this is indicated with a check symbol at the motor.

The machine picture itself also indicates the coupling alignment.



Save the measurement result.



Go to shimming

EVALUATING THE RESULT

The angle and offset values are used to determine the alignment quality. These values are compared with the alignment tolerances to determine whether correction is necessary. If suitable tolerances are selected in the tolerance table, the symbols described above indicate if the angle and offset values are within tolerance or not.

The foot values indicate the movable machine's foot positions where corrections can be made.

Depending on the result, the program will also guide the user.

First, the program will always recommend the user to save the measurement.

Then, if the measurement result shows that the machine is misaligned, the user will be recommended to go to shimming.

If the measurement result is within tolerance and has been saved, the system will recommend the user to exit the measurement.

SHIMMING

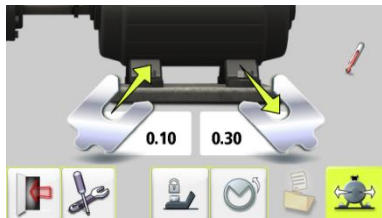

The Shimming screen shows foot values in the vertical direction as suitable shim values (0.05 mm / 1 mil).

The arrows show if shims must be added or removed to adjust the machine in the vertical direction.

The check signs show that shimming is not needed.

When shimming is completed, continue to alignment for adjustments in the horizontal direction.



Go to alignment.

ALIGNMENT

If the machine has been adjusted vertically in the shimming screen, go directly to alignment in the horizontal direction.

If the machine has not been adjusted in the shimming screen, alignment in the vertical direction has to be done first.

Vertical direction

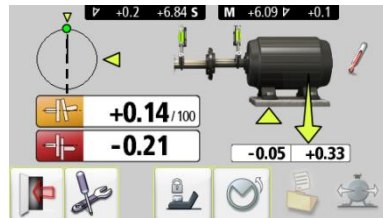

Rotate the shafts to the 12 or 6 o'clock position to make adjustments in the vertical direction. The angle guide helps you to reach the right position.

Adjust the machine vertically until the values for both angular and parallel alignment are within tolerance. The arrows by the feet show in which direction the machine should be moved.

Horizontal direction

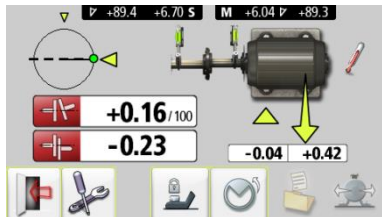

Rotate the shafts to the 3 or 9 o'clock position to make adjustments in the horizontal direction. The angle guide helps you to reach the right position.

Adjust the machine horizontally until the values for both angular and parallel alignment are within tolerance. The arrows by the feet show in which direction the machine should be moved.

Check and re-measure

Rotate the shafts back to the 12 or 6 o'clock position and check that the machine is still within tolerance.

Alignment is now completed. To confirm the result, re-do the measurement.



Re-measure.

FEET LOCK FUNCTION

In some cases the machine that is displayed as the movable machine is not movable, or maybe some of the feet are not adjustable. In order to perform proper alignment in these cases, the Feet Lock function can be used. This function allows you to select which feet are locked and which feet are adjustable.

Feet Lock is available both in shimming and alignment.



Touch the Feet Lock icon to enter the Feet Lock function.

Enter dimensions. The required distances are those between the first and second pairs of feet on the stationary machine and between the first pair of feet on the stationary machine and the first pair of feet on the movable machine.



Select the two pairs of feet you want to lock.

Feet Lock Shimming



Shim values are shown for the two pairs of feet that are not locked.

Feet Lock Alignment

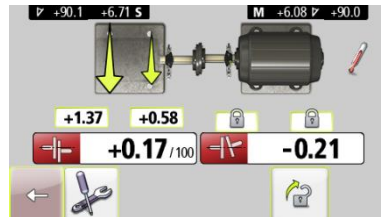

Live values are shown for the two pairs of feet that are not locked.

SCREEN FLIP



Screen Flip enables the user to see the machine set-up from the actual view.

Select screen flip in settings.

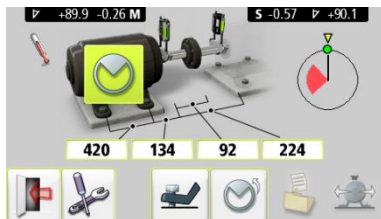

OTHER FEATURES

Looseness indicator



The system has a function for detecting coupling backlash and looseness in order to achieve optimum accuracy. The system will display the looseness indicator if one of the following conditions is met:

- The M and S units are more than 3° apart.
- The mutual angular position changes more than 0.7° from that when the first measurement point was taken.

When the coupling backlash or looseness is eliminated to avoid any of the above conditions, the looseness indicator will automatically disappear.

Target Value symbol



When Target Values are used in the measurement, this is indicated with the Target Value symbol in the upper right corner of the screen.

Coupling gap

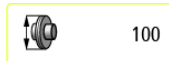

The result can be presented as a coupling gap.

Coupling diameter can be entered in settings.

Measurement with disabled inclinometers

If the inclinometers are not functioning properly, e.g. in high vibrations, they can be disabled.

- Turn off the inclinometers in Settings.

When the inclinometers are disabled the system will work as normal with the following exceptions:

- The readings have to be registered according to the "clock method". Register the first reading at 9 o'clock, rotate the shafts 180° and register the second reading at 3 o'clock, rotate 90° back to 12 o'clock to register the third and final reading.

- During alignment, use the change view icon to change from horizontal to vertical view of the machine and vice versa.



SHAFT ALIGNMENT VERTICAL MACHINES

INTRODUCTION

Shaft alignment: Determine and adjust the relative position of two machines that are connected, such as a motor and a pump, so that the rotational centers of the shafts are collinear, when the machines are working at a normal operating temperature. Correction of vertical shaft alignment is done by moving the flange of the machine until the shafts are aligned within given tolerances. A tolerance table is available in the system.



The Fixturlaser system has two measuring units that are placed on each shaft by using the fixtures supplied with the system.



After rotating the shafts to different measuring positions, the system calculates the relative distance between the two shafts in two planes. The distances between the two measuring planes, distance to the coupling, number of bolts and pitch circle diameter are entered into the system. The display box then shows the actual alignment condition together with the position of the feet. Adjustment of the machine can be

made according to the values displayed. The angular misalignment is corrected by placing shims under the bolts and offset is corrected by moving them laterally.

The alignment results can be saved in the memory manager. The measurements in the memory manager can easily be transferred to a PC for further documentation purposes.

PRE-ALIGNMENT FUNCTIONS

In an effort to obtain the best possible conditions for shaft alignment, it is necessary to perform some pre-alignment checks. In many cases it is necessary to make these checks in order to obtain precise alignment. It is often impossible to reach the desired alignment results if you do not make any pre-alignment checks.

Before going on site, check the following:

What are the required tolerances?

Any offsets for dynamic movements?

Are there any restrictions for mounting the measuring system?

Is it possible to rotate the shafts?

What shim size is needed?

Before setting up the alignment system on the machine, check the machine foundation, bolt and shim conditions. Also check if there are any restrictions in adjusting the machine (if e.g. there is enough space to move the machine).

After the visual checks have been performed, there are some conditions that have to be considered:

- Check that the machine has the right temperature for alignment?
- Take away old rusty shims (check that you can remove shims).
- Check coupling assembly and loosen the coupling bolts.
- Check soft foot conditions.

- Mechanical looseness.
- Check coupling and shaft run-out.
- Pipe work strain.
- Coarse alignment.
- Check coupling gap (axial alignment).

MOUNTING

The sensors are mounted as described in chapter “Shaft Alignment Horizontal Machines”.

STARTING THE PROGRAM



Start the program by touching the Vertical Shaft Alignment icon in the Main Menu.



Go to Settings for selecting measurement method and other settings.

SETTINGS

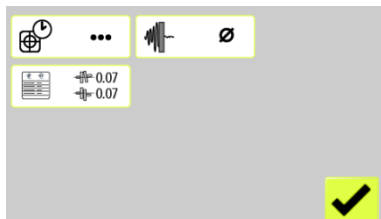

These settings are unique for this application.

For most of the settings, the current selection is shown in the icon.

Sampling time

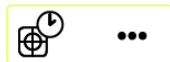

Opens window for selection of sampling time. Select normal or long sampling time.

Long sampling time is suitable for high vibration environments.

Tolerance table

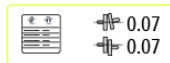

Opens the tolerance table. See chapter “Tolerance table”.

Adjustable screen filter

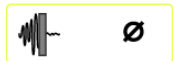

Opens window for activating or deactivating the adjustable screen filter.

Note: The adjustable screen filter should be deactivated for normal operation, and only activated in environments with severe vibrations.

Confirm



Exits the Settings and returns to the application.

ENTER DIMENSIONS

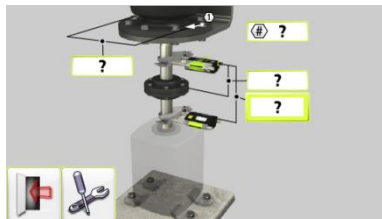

The screen displays the movable machine. The traffic lights show green when the laser hits the detector.

Select the dimension boxes to enter dimensions.

Measure and enter dimensions and tolerance.

You must enter all the distances. The distance between the sensors, the distance between the centre of the coupling and the M-sensor, and the pitch circle diameter and the number of bolts.

Up to 8 bolts can be entered.

MEASUREMENT METHOD

In the Vertical Shaft Alignment program, machinery positions are calculated by taking three points with 180° of rotation.

MEASUREMENT POINT REGISTRATION

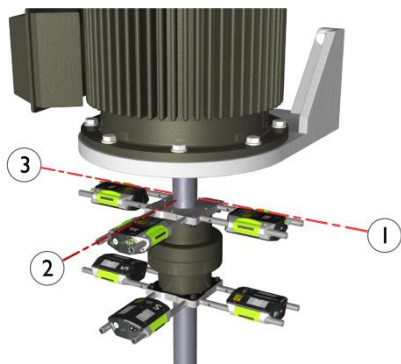

Place yourself at the position corresponding to the second measurement position, where it is easiest to turn the shafts through 180° .

The first measurement position has to be at bolt number 1.

Tip: Mark the positions 1, 2 and 3 before you start measuring.

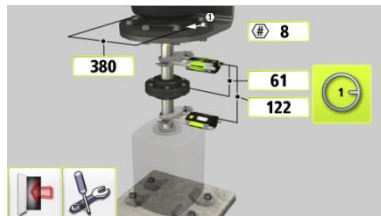

Set the sensors at approximately the same rotational angle at the first measurement position, with bolt number 1 to the right.



Touch the register icon.

This registers the first reading.

Rotate the shafts 90° to the second position
(where you are standing).

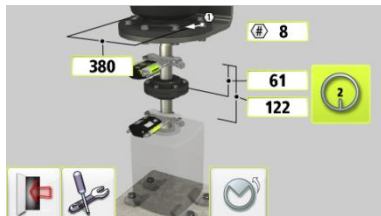

Touch the register icon.

This registers the second reading.

Rotate the shafts 90° to the third position,
to the left.

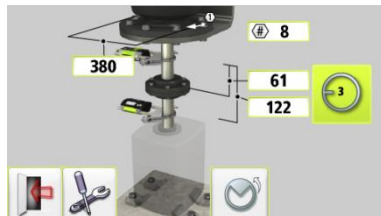

Touch the register icon.

This registers the third reading.

MEASUREMENT RESULTS

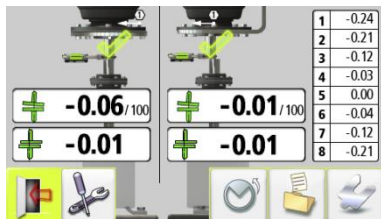

The Measurement Result screen shows coupling values in both directions, and bolt values.

The symbol to the left of the coupling values indicates the angular direction and offset, and also if the values are within tolerance.



Within tolerance (green).



Within double tolerance (yellow and inverted).



Out of double tolerance (red and inverted).



When a coupling is in tolerance in one direction, this is indicated with a check symbol at the motor.



Save the measurement result.



Go to shimming

EVALUATING THE RESULT

The angle and offset values are used to determine the alignment quality. These values are compared with alignment tolerances to determine if any correction is necessary. If suitable tolerances are selected in the tolerance table, the symbols described above indicate if the angle and offset values are within tolerance or not.

The bolt values indicate the movable machine's bolt positions where corrections can be made.

SHIMMING



The Shimming screen shows bolt values as suitable shim values (0.05 mm / 1 mil).

Adjust the angular error by placing shims under the bolts as required.

The arrow show if shims must be added to adjust the machine.

The check sign shows that shimming is not needed.

When shimming is completed, continue to alignment for adjustments of parallel offset.



Go to alignment.

ALIGNMENT



If the angular error has been correctly adjusted in the shimming screen the angular value should now be in tolerance.

Now adjust the parallel offset in both directions. The parallel offset is displayed live in the first direction when the sensors are placed in position number 1, and in the second direction when they are placed in position number 2.

Check that both the angular value and the parallel offset are within the required tolerances once the adjustments are completed.

Alignment is now complete. To confirm the result, re-do the measurement.



Re-measure.

MACHINE DEFINED DATA

INTRODUCTION

If the sensors are placed at the same place each time a machine (or more identical machines) is measured, it can be convenient to preload the relevant parameters. The data that can be preloaded are:

- The name of the specific machine.
- Distances for the machine, the distance between the sensors (where fixture points are fixed), the distance between the centre of the coupling and the M-sensor, the distance between the M-sensor and the first pair of feet and the distance between the first and the second pairs of feet.

- Target Values as feet values or angle and offset values.
- Tolerances.

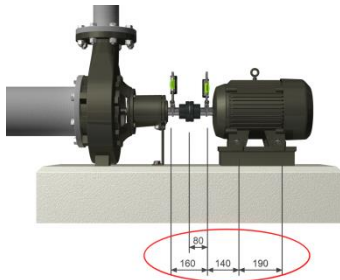

NOTE!

When using Machine Defined Data, the sensors must always be placed according to the preloaded distances to get correct measurement results.

STARTING THE PROGRAM



Start the program by touching the Machine Defined Data icon in the Main Menu.

Select machine

Machines can be selected by touching its machine name.

This starts Shaft Alignment with machine defined data for the selected machine.

USING MACHINE DEFINED DATA

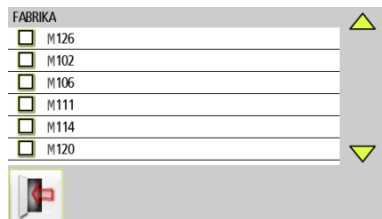

A list of machine types with preloaded data is shown.

SOFTCHECK™

INTRODUCTION

A soft foot condition needs to be corrected before any alignment takes place. If not, the measurement result will be of no value. It is more or less impossible to establish if there is a soft foot condition without using some kind of measurement tool. The Fixturlaser Alignment System's built-in Softcheck program checks each foot and displays the result in mm or mils.

The Softcheck program is entered from the Horizontal Shaft Alignment program.

STARTING THE PROGRAM



Start the Softcheck by touching its icon in the Shaft Alignment program.

Place the sensors at the 12 o'clock position.

All the distances must be entered, before checking for soft foot.

Check that all foot bolts are firmly tightened.

MEASUREMENT VALUE REGISTRATION



Select a bolt of your choice by touching its icon.

1. Loosen the bolt fully and wait a few seconds.
2. Tighten the bolt firmly, preferably with a dynamometric wrench.
3. Register the measurement value.



Register the measurement value by touching the confirmation icon.



Continue with the rest of the bolts.

Re-measurements can be done at any time by touching the icon for the requested bolt again.

MEASUREMENT RESULT AND CORRECTIONS



Make the necessary corrections and then check each foot again (the values show approximately how many shims that are needed to eliminate the soft foot).

TARGET VALUES

INTRODUCTION

Most machines develop a certain amount of heat while running. In the best case both the driving and the driven machine are affected equally requiring no input of compensation values. But in some applications the driven machine is either hotter, i.e. a pump for hot liquid, or cooler than the driving machine.

Machine manufacturers define the thermal expansion of machines differently, but in most cases you will find it as a factor of deliberate misalignment expressed in parallel offset and angular error.

In the Fixturlaser EVO system, you can pre-set target values before starting your

alignment work. Accepted values are feet values and angle and offset values.

The entered values are target values. Target values mean that these are the values at which the machine should be positioned when not running (cold condition) in order to obtain correct alignment while the machine is running (hot condition).

STARTING THE PROGRAM



Start the Target Values program by touching its icon in Settings.



Select one of two ways to express the offset values: Feet values or angle and offset values.

FEET VALUES

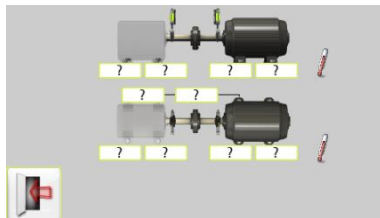

Touch the feet value boxes. Enter target values for the feet in mm or mils according to the pre-set measurement unit together with the required distances.

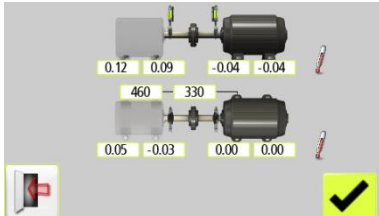

In the example above, the stationary machine will shrink vertically by 0.12 mm at the rear feet and 0.09 mm at front feet while the movable machine will expand 0.04 mm while running.

Horizontally, the rear feet will move 0.05 mm towards you and the front feet will move 0.03 mm away from you while the movable machine does not change its position while running.

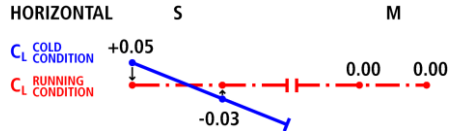
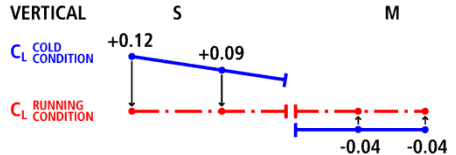

After having entered these feet values, the system calculates how the movable machine should be positioned (target position) in cold condition in order to obtain perfect alignment during running condition.

ANGLE AND OFFSET VALUES

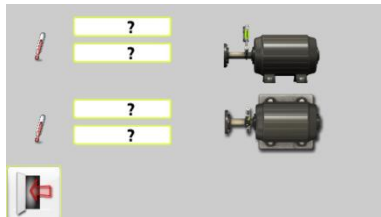

Touch the value boxes and enter target values for the angles in mm/100 mm and target values for the offsets in mm, or mils/inch and mils, according to the pre-set measurement unit.

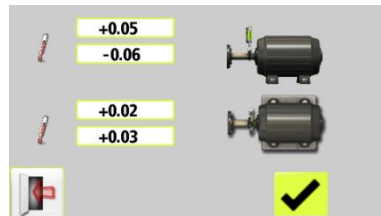

In the example above, the movable machine should be vertically adjusted to a position with an angular misalignment of +0.05 mm/100 mm and an offset of -0.06 mm.

Horizontally, the movable machine should be positioned with a +0.02 mm/100 mm angular misalignment and a +0.03 mm offset, in cold condition to obtain perfect alignment while running.

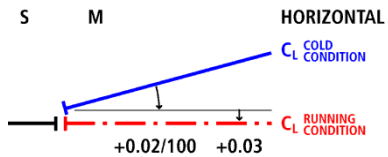
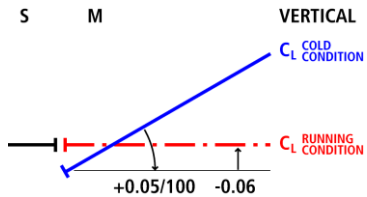

TOLERANCE TABLE

INTRODUCTION

Alignment tolerances depend to a large extent on the rotation speed of the shafts. Machine alignment should be carried out within the manufacturer's tolerances. The table provided in Fixturlaser EVO can be helpful if no tolerances are specified. The suggested tolerances can be used as a starting point for developing in-house tolerances when the machinery manufacturer's recommended tolerances are not available. The tolerances are the maximum allowed deviation from desired values.

It is also possible to enter a customized tolerance.

OPEN THE TOLERANCE TABLE

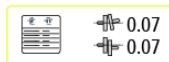

Open the Tolerance Table by touching this icon in Settings.

	 rpm	\pm mm/100	\pm mm
<input type="checkbox"/>	0-2000	0.08	0.10
<input checked="" type="checkbox"/>	2000-3000	0.07	0.07
<input type="checkbox"/>	3000-4000	0.06	0.05
<input type="checkbox"/>	4000-6000	0.05	0.03
<input type="checkbox"/>	MY TOL	0.06	0.08



Tolerance Table mm-mode

<input type="checkbox"/>	rpm	\pm mils/"	\pm mils
<input type="checkbox"/>	3600	0.5	2.0
<input type="checkbox"/>	1800	0.7	4.0
<input checked="" type="checkbox"/>	1200	1.0	6.0
<input type="checkbox"/>	900	1.5	8.0
<input type="checkbox"/>	MY TOL	0.8	5.0



Tolerance Table inch-mode

SELECT TOLERANCE



Select the tolerance to use in the alignment by touching its check box to the left.



Confirm.

CUSTOMIZED TOLERANCES

A customized tolerance can be entered at the last row of the tolerance table.

Enter customized tolerance by touching any of the fields, name/rotation speed to the left and tolerance values to the right.

MEMORY MANAGER

FILE MANAGER

<input checked="" type="checkbox"/>	M129A	2014-03-10 20:53	▲
<input type="checkbox"/>	M129	2014-03-10 20:42	
<input type="checkbox"/>	M119A	2014-03-10 14:52	
<input type="checkbox"/>	M119	2014-03-10 13:49	
<input type="checkbox"/>	M115	2014-03-05 10:44	
<input type="checkbox"/>	M114A	2014-03-04 17:42	
<input type="checkbox"/>	M114	2014-03-04 17:10	▼

	
---	---

Open file

Touch a file to open it.

Scroll



Scrolls one page up.



Scrolls one page down.

Select files



Touch the check box to the left to select a file.

Delete



Deletes selected file.

Archive



Goes to archive

(only available when it contains folders with older files).

Exit



Exits the Memory Manager.

The Memory has the capacity to store approximately 1200 measurements. When the number of measurements, exceeds 100 measurements in the file manager, a folder with the older files will be automatically created. These folders can then be found in the archive.

NOTE: When there are a lot of files in the memory, processing can be slow.

SAVE MEASUREMENT

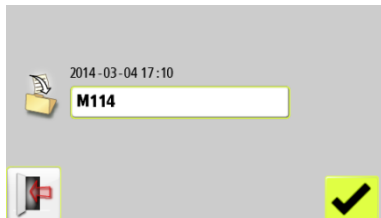

Enter file name

Touch the white field to enter a file name.

Confirm



Confirm.

When saving a measurement, both a text file and a picture file (bmp) are created.

TRANSFER FILES TO A PC

1. Turn on the display unit and stay in the Main Menu.
2. Attach the display unit to the PC with the USB cable.



3. Touch the connect to PC icon.

The display unit will appear as a mass storage device on the PC.

4. The files in the display unit can be transferred to the PC using the ordinary functions in Windows Explorer (i.e. cut, copy or drag and drop).

In the PC there will be two files for each measurement; a picture file (.bmp) and a text file (.txt). The picture file shows the same picture as in the memory. The text file shows just the measurement data.

It is recommended that you delete the files from the display unit after they have been safely transferred in order to avoid full memory.

SHAFT ALIGNMENT HORIZONTAL MACHINES



The screen displays measurement results, dimensions, target values if any, file name, date and time, serial number of the display unit, program, program version and tolerances.



Exit the measurement file.

SHAFT ALIGNMENT VERTICAL MACHINES

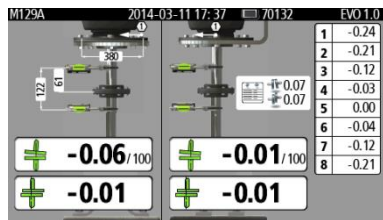

The screen displays measurement results, dimensions, file name, date and time, serial number of the display unit, program, program version and tolerances.



Exit the measurement file.

GLOBAL SETTINGS

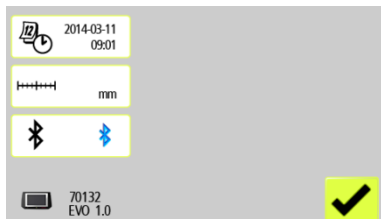

The global settings menu includes settings that are universal for all applications.

For most of the settings, the current selection is shown in the icon.

The program version number is also shown on this screen.

Date and time



Opens window for date and time settings.

Measurement unit

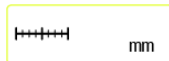

Changes between mm mode and inch mode.

Bluetooth settings



Opens window for bluetooth settings.

Confirm



Exits the Global Settings.

BLUETOOTH SETTINGS

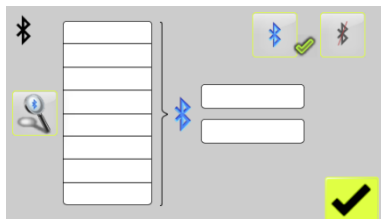

Communication



Activate Bluetooth.



Deactivate Bluetooth.

Pairing Bluetooth units

Touch the search icon to search for units that are pair able.



Search for Bluetooth units.

Pair able units will appear in the search list to the left.

The wireless units must be switched on for the display unit to discover them. The display unit will only discover units approved by Fixturlaser.

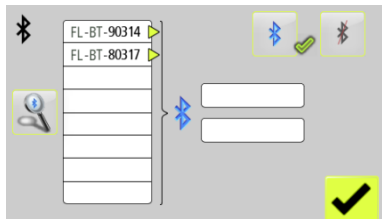

Touch the units to pair in the search list.
(Maximum two units.)

Paired units will be moved to the boxes
beside the blue B.

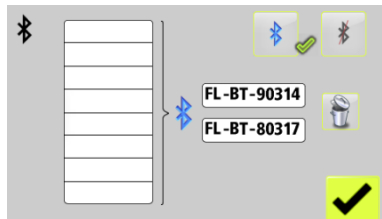

Units that are paired to the display unit are
shown in the boxes beside the blue B.

The display unit will only communicate with
units that are paired and displayed in the
boxes.

If there are units paired to the display unit,
they have to be unpaired before it is
possible to pair new units.

Unpairing Bluetooth units



Touch the delete icon to unpair units.

DISPLAY UNIT EVO D



1. 5" Touch screen
2. On button with status LED
 - a. Continuously green – ON
3. Display Unit battery status
 - a. Continuously green – connected to charger and battery fully charged
 - b. Continuously amber – connected to charger and charging
 - c. Flashing red - <10% battery capacity
4. USB slave (IP 67)

OPERATING MODES

The display unit has two operating modes: On and Off.



To turn on the unit, press the ON button.



To turn off the unit, touch the Off icon in the main menu.

In case the system fails to respond, it is possible to turn it off by pressing down the ON button for more than 15 seconds.

CONNECTIONS

The main connection for the Display Unit is the built in Bluetooth connection. See chapter “Global settings” for instructions on how to pair measurement units.

The USB slave connector is used to charge the battery and for attaching the Display Unit to a PC to transfer measurement data. When attached to a PC the unit will act as a Mass Storage Device.

POWER SUPPLY

The Fixturlaser EVO is powered by a high-capacity rechargeable Li-Ion battery in the display unit, or by the external power unit.

The operating time of the batteries is approximately 8 hours when the system is used for a typical alignment work.

If the system turns off due to low power, the resume function will save the data. When the system is turned on again after battery recharge or connection of external power, you will be prompted to choose whether to return to the state when the unit was turned off (i.e. resuming operation without loss of data) or start the main menu.

The external power unit is connected to the USB mini connector on the display unit and to a wall socket with 110 - 240 Volts.

When the external power supply is connected, the unit will automatically start charging the batteries. This will be indicated by the battery status LED. The charging time is approximately 8 hours for fully drained batteries. The charging time will be longer if the unit is turned on while being charged.

When used in typical conditions the batteries will sustain good capacity for approximately 2-3 years before needing replacement. Contact your sales representative for battery re-placement.

The batteries contain safety circuitry to operate safely with the display unit. The unit can therefore only be used with the Li-Ion

batteries supplied by Fixturlaser. Improper replacement of batteries can cause damage and risk for personal injury. Please refer to the chapter on safety for further instructions.

BACKLIGHT

If no icon is pressed within 30 minutes the backlight will dim automatically.

Press anywhere on the screen to turn the backlight on again.

AUTO-OFF

If no icon is pressed within 60 minutes the system will turn off automatically.

RESUME FUNCTION

If the system is turned off due to low power, the resume function will save the data.



When the system is turned on again after charging the batteries, you will be prompted to choose whether to return to the stage when the system was turned off (i.e. resuming operation without loss of data) or start the Main Menu.

UPGRADING THE SOFTWARE

Any upgrades of the software will be distributed or made available for download on our website.

1. Turn on the display unit and stay in the Main Menu.
2. Attach the display unit to the PC with the USB cable.



3. Touch the connect to PC icon.

The display unit will appear as a mass storage device on the PC.

4. Copy the file containing the new software to the display unit.

NOTE: A zipped file must be unzipped before copying it to the display unit.

5. Disconnect the display unit from the PC and wait until the display unit turns itself off (this can take several minutes).
6. Turn on the display unit. The upgrade file will be automatically detected and installed. This can take approximately one minute. Wait until the Main Menu is displayed, and the DU is then ready to be used again.
7. Settings and stored measurements will not be affected by an upgrade.

CALIBRATING THE TOUCH SCREEN

In order to make the touch screen to respond to the icons on the display, it may be necessary to recalibrate it from time to time.

Screen calibration procedure:

- Start the system.
- Wait until the main menu appears.
- Press down on the screen somewhere outside of the icons for 10 seconds.
- The screen calibration function should start.
- Touch and hold down on the target displayed until it moves.

- Repeat the step above on the 4 new positions of the target.



NOTE!

For best results please use a stylus for calibration.

SENSORS M3 AND S3



1. ON/OFF button with status indication LED
 - a. Continuously green – On
 - b. Switching green/red – Gyro activated.
2. Mini USB for charging
3. Laser transmission indication LED
 - a. Green – laser transmission
4. Bluetooth indication LED
 - a. Continuously blue – paired and ready.
 - b. Flashing blue – searching/ready to pair
 - c. No light – Bluetooth disabled.



5. Battery status button – press to instantly show the battery status (also works when the unit is switched off).

6. Battery status LED
- a. One LED continuously red – less 10% charge left.
 - b. One LED flashing red – less than 5% charge left.
 - c. One LED continuously orange – charging
 - d. One LED continuously green – fully charged.
7. Battery status LED when battery button is pressed
- a. Continuously green – battery status
 - b. Rolling green – battery charging

OPERATING MODES

M3 and S3 units has two operating modes:
On and Off.

Turn the units on and off by pressing the ON/OFF button firmly.

In case the units fail to respond, it is possible to turn it off by pressing down the ON button for more than 10 seconds.

CONNECTIONS

Bluetooth connection

The main connection for M3 and S3 units is the built in Bluetooth connection. The units will automatically connect to the display unit when turned on as long as they are paired. See chapter “Global settings” for instructions on how to pair measurement units to the display unit.

To avoid accidental Bluetooth transmission in a restricted area the Bluetooth function can be completely disabled – contact your local sales representative for more information.

If the Bluetooth has been disabled (as indicated by the fact that the Bluetooth LED is not flashing or continuously blue when the unit is turned on) it can be enabled by

pressing the battery status button quickly 5 times in a row.

POWER SUPPLY

The M3 and S3 units are powered by a high-capacity rechargeable Li-Ion cell, or by the external power unit.

The operating time of the batteries is approximately 17 hours when the system is used for a typical alignment work (continuously on).

The M3 and S3 units can be charged with the supplied combined charger or any 5V USB charger or battery life extender.

When the external power supply is connected, the unit will automatically start charging the batteries. This will be indicated by the first battery status LED turning orange, when the unit is fully charged the LED will turn green. By pressing the battery

status button the exact charging status can be monitored.

The charging time is approximately 8 hours for fully drained batteries. The charging time will be longer if the unit is turned on while being charged.

When used in typical conditions the batteries will sustain good capacity for approximately 2-3 years before needing replacement. Contact your sales representative for battery re-placement.

The batteries contain safety circuitry to operate safely with the unit. The unit can therefore only be used with the Li-Ion batteries supplied by Fixturlaser. Improper replacement of batteries can cause damage and risk for personal injury. Please refer to

the chapter on safety for further instructions.

TECHNICAL SPECIFICATION – EVO D

Part. No. I-0934

Housing Material	Brushed Anodized Aluminum frame and high impact ABS plastic over molded with TPE rubber
Operating Temp	-10 to 50°C (14 to 122°F)
Battery Charging Temp, system on	0 to 40°C (32 to 104°F)
Storage Temp	-20 to 70°C (-4 to 158°F)
Long term storage temp	Room temp. 18 to 28°C (64 to 82°F)
Relative humidity	10 – 90%
Weight	0,4 kg (lbs) with battery
Dimensions	103mm x 181mm x 29 mm (4,1 in x 7,1 in x 1,1 in)
Environmental protection	IP65 (Dust tight and protected against water jets)
Flash storage memory	500 Mb > 1200 measurements
Display	Colour TFT-LCD backlit, sunlight readable
Display size	5" (127mm) diagonal (111 x 63 mm)
Display resolution	480x272 pixels
Colour depth	262 000 colours

Interface	5" High Impact Polyester laminated touch screen with enhanced transmission and reduced glare
Connectors	1 USB 2.0 mini port (IP 67)
Wireless communication	Class II Bluetooth transmitter with multi-drop capability
Power supply	High performance rechargeable Li-Ion battery or external power supply
Operating time	8 hours continuous use
Battery Charging time (system off, room temperature)	8 h
Battery Capacity	10.4 Wh
LED indicators	Unit state and battery state indicators

Specifications are subject to change without notice.

TECHNICAL SPECIFICATION – M3 AND S3

Part. No. M3 I-0913, S3 I-0914

Housing Material	Anodized Aluminum frame and high impact ABS plastic over molded with TPE rubber
Operating Temp	-10 to 50°C (14 to 122°F)
Storage Temp	-20 to 70°C (-4 to 158°F)
Long term storage temp	Room temp. 18 to 28°C (64 to 82°F)
Battery Charging Temp	0 to 40°C (32 to 104°F)
Relative humidity	10 – 90%
Weight	192 g (6,8 oz) with battery
Dimensions	92mm x 77mm x 33mm (3,6 in x 3,0 in x 1,3 in)
Environmental protection	IP65 (Dust tight and protected against water jets)
Laser	650 nm class II diode laser
Laser line fan angle	6°
Laser line width (1/e2)	1.6 mm
Laser line divergence (full angle)	0.25 mrad
Laser power	< 1 mW
Measurement distance	Up to 10m
Detector	2nd gen. scientific grade CCD

Detector length	30mm (1,2 in)
Detector angular subtense	30mrad/m (3mm/100mm per meter)
Detector resolution	1 μ m
Measurement accuracy	0,3% \pm 7 μ m
Signal processing:	Digital signal processing with Sidespot rejection, edge detection, ambient light elimination and anti-vibration mode
Ambient light protection	Optical filtering and digital ambient light signal elimination
Inclinometer:	Dual High Performance MEMS inclinometers
Inclinometer resolution	0,01 $^{\circ}$
Inclinometer accuracy	\pm 0,2 $^{\circ}$
Gyroscope*	6-Axis MEMS Inertial Motion Sensor with drift compensation and automatic field calibration
Gyroscope accuracy	\pm 1 $^{\circ}$
Wireless communication	Class II Bluetooth transmitter
Communication range	10 m (33 ft)
Connectors	1 USB Mini port (IP67); Charging: 5V, 0,5A Communication: with separate USB/RS 485 adapter cable

Power supply	High performance Li Ion battery or external power.
Operating time:	17 hours continuous use (measuring)
Battery Charging time (system off, room temperature)	8 h
Battery Capacity	10.4 Wh
LED indicators	Unit state, laser transmission and 5 battery status indicators with instant battery check

Specifications are subject to change without notice.

*Gyroscope functions are not implemented in the NXA mini software.



Publication No. P-025 I -GB

© 2014 Elos Fixturlaser AB, Mölndal, Sweden

All rights reserved. No part of this manual may be copied or reproduced in any form or by any means without prior permission from Elos Fixturlaser AB.

www.fixturlaser.com